

EMC Components

Ferrite Beads

SMD

ACB Series

FEATURES

- The ACB series provide effective EMC suppression in signal lines through simple in-series implementation. It is thus ideal for circuits in which it is difficult to bypass high-frequency components to ground.
- Reflection components are highly suppressed through the use of a special ferrite material and an advanced internal structure that minimizes stray capacitance. This product is, therefore, an excel-

lent countermeasure for noise radiation in high-speed digital signal lines.

- The ultra-miniature 1.6×0.8 mm part exhibits a 600Ω impedance at 100MHz, which is the larger type 2012.
- Both the 1608 and 2012 types are available in a large number of impedance values. Different characteristics can thus be achieved without changing PC board land patterns.

SHAPES AND DIMENSIONS/CIRCUIT DIAGRAM

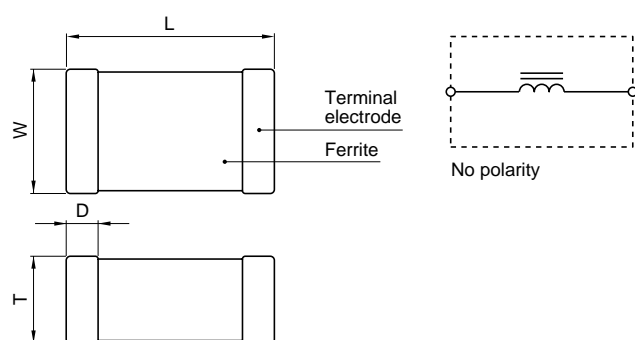

Dimensions in mm

Shape	L	W	T	D
1608	1.6 ± 0.15	$0.8 \pm 0.3, -0.1$	$0.8 \pm 0.3, -0.1$	0.3 ± 0.2
2012	2 ± 0.2	1.25 ± 0.2	0.9 ± 0.2	0.4 ± 0.2

RECOMMENDED PC BOARD PATTERNS

REFLOW AND FLOW SOLDERING

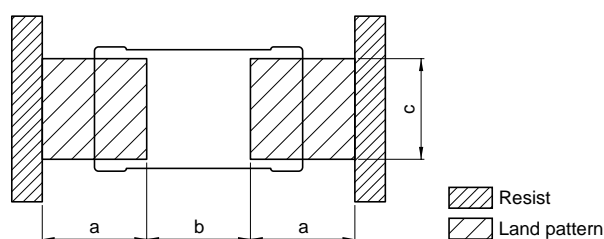

Dimensions in mm

Type	a	b	c
ACB1608	1	0.6	0.8
ACB2012	1	1	1

ELECTRICAL CHARACTERISTICS

Part No.	Impedance (Ω) [100MHz]	DC resistance (Ω)max.	Rated current (mA)max.
ACB1608L-015-□*	$15 \pm 25\%$	0.1	500
ACB1608L-030-□	$30 \pm 25\%$	0.3	400
ACB1608L-060-□	$60 \pm 25\%$	0.4	300
ACB1608L-120-□	$120 \pm 25\%$	0.5	200
ACB1608L-300-□	$300 \pm 25\%$	1.5	200
ACB1608M-040-□	$40 \pm 25\%$	0.3	400
ACB1608M-080-□	$80 \pm 25\%$	0.5	300
ACB1608M-120-□	$120 \pm 25\%$	0.7	200
ACB1608M-300-□	$300 \pm 25\%$	1.2	150
ACB1608M-600-□	$600 \pm 25\%$	1.8	100
ACB1608H-015-□	$15 \pm 25\%$	0.3	400
ACB1608H-030-□	$30 \pm 25\%$	0.4	300
ACB1608H-060-□	$60 \pm 25\%$	0.7	200
ACB1608H-120-□	$120 \pm 25\%$	1.2	150
ACB1608H-300-□	$300 \pm 25\%$	1.8	100
ACB2012L-015-□	$15 \pm 25\%$	0.1	600
ACB2012L-030-□	$30 \pm 25\%$	0.3	500
ACB2012L-060-□	$60 \pm 25\%$	0.4	400
ACB2012L-120-□	$120 \pm 25\%$	0.5	300
ACB2012L-300-□	$300 \pm 25\%$	1	250
ACB2012L-600-□	$600 \pm 25\%$	2	150
ACB2012M-040-□	$40 \pm 25\%$	0.3	500
ACB2012M-080-□	$80 \pm 25\%$	0.4	400
ACB2012M-120-□	$120 \pm 25\%$	0.5	300
ACB2012M-300-□	$300 \pm 25\%$	0.9	200
ACB2012M-600-□	$600 \pm 25\%$	1.3	100
ACB2012H-015-□	$15 \pm 25\%$	0.3	400
ACB2012H-030-□	$30 \pm 25\%$	0.4	300
ACB2012H-060-□	$60 \pm 25\%$	0.5	300
ACB2012H-120-□	$120 \pm 25\%$	0.9	200
ACB2012H-300-□	$300 \pm 25\%$	1.3	100

* □: Packaging style (T: Taping [$\phi 180$ mm reel], TL: Taping [$\phi 330$ mm reel], B: Bulk)

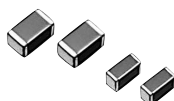

EMC Components

ACB Series

Ferrite Beads SMD

TYPICAL ELECTRICAL CHARACTERISTICS Z, X, R vs. FREQUENCY CHARACTERISTICS

ACB1608L-015

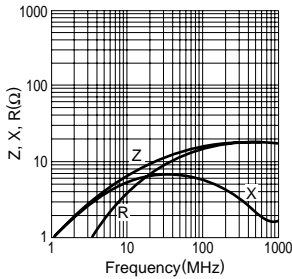

ACB1608L-030

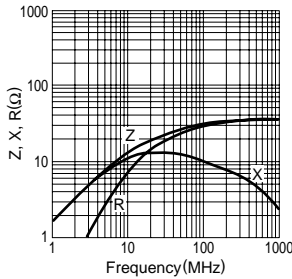

ACB1608L-060

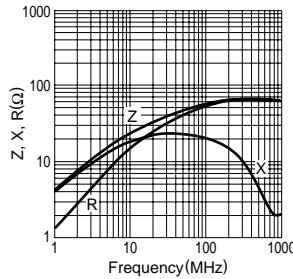

ACB1608L-120

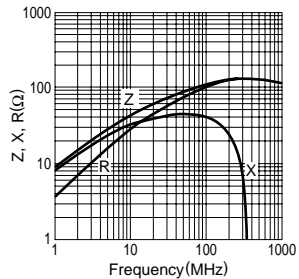

ACB1608L-300

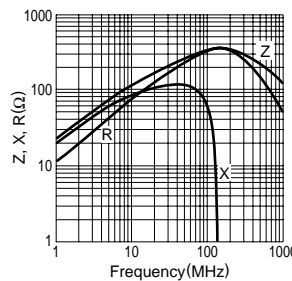

ACB1608M-040

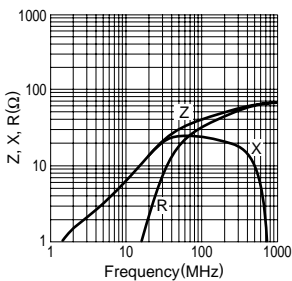

ACB1608M-080

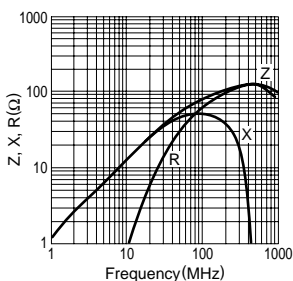

ACB1608M-120

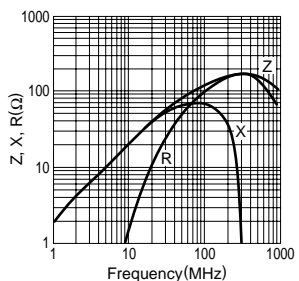

ACB1608M-300

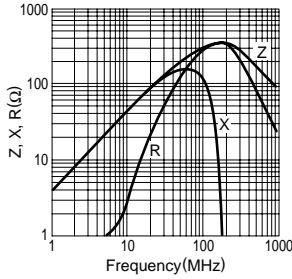

ACB1608M-600

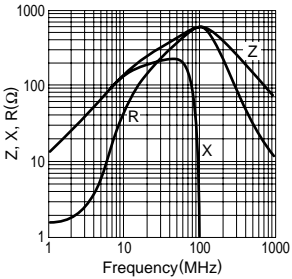

ACB1608H-015

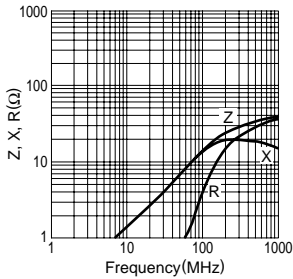

ACB1608H-030

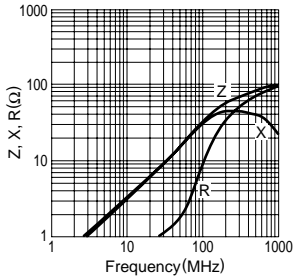

ACB1608H-060

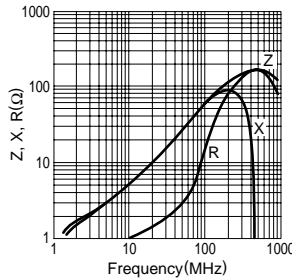

ACB1608H-120

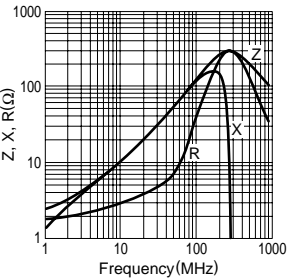

ACB1608H-300

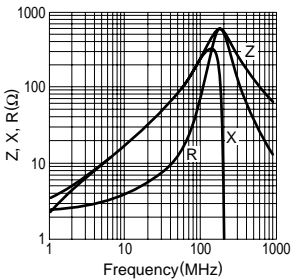

ACB2012L-015

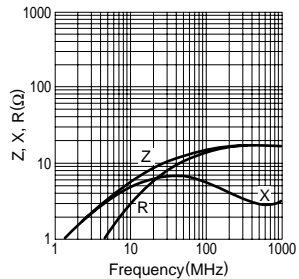

ACB2012L-030

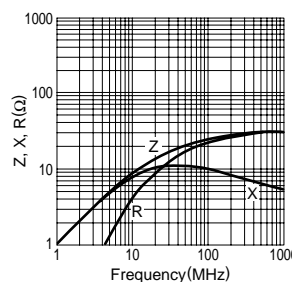

ACB2012L-060

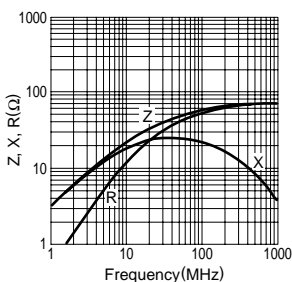

ACB2012L-120

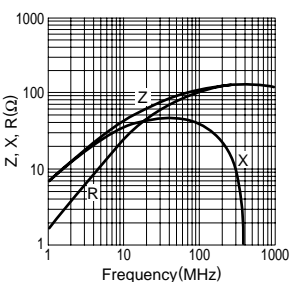

ACB2012L-300

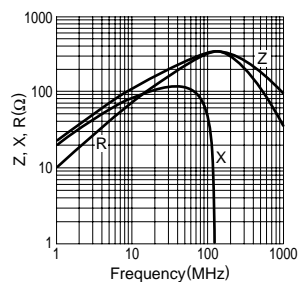

• TEST EQUIPMENT: RF IMPEDANCE ANALYZER YHP4191A

⚠ Specifications which provide more details for the proper and safe use of the described product are available upon request.
All specifications are subject to change without notice.

EMC Components

Ferrite Beads

SMD

ACB Series

TYPICAL ELECTRICAL CHARACTERISTICS

Z, X, R vs. FREQUENCY CHARACTERISTICS

ACB2012L-600

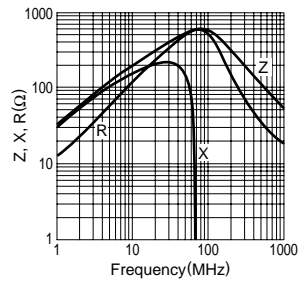

ACB2012M-040

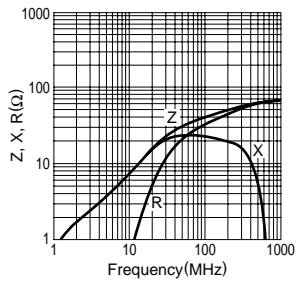

ACB2012M-080

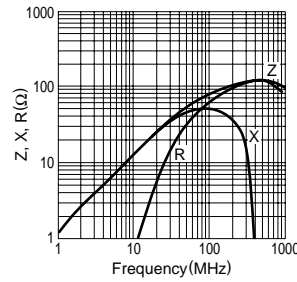

ACB2012M-150

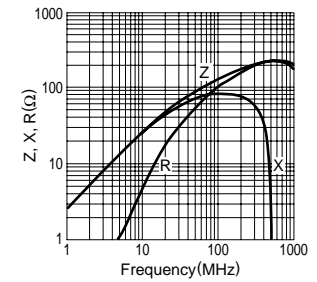

ACB2012M-300

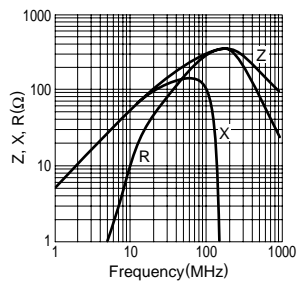

ACB2012M-600

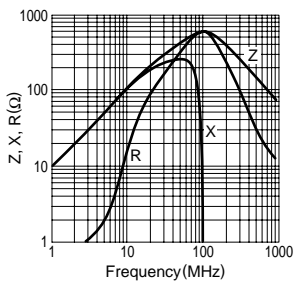

ACB2012H-015

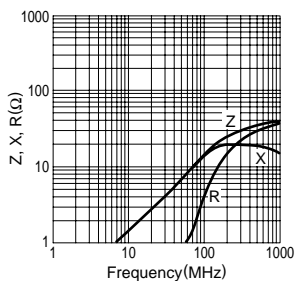

ACB2012H-030

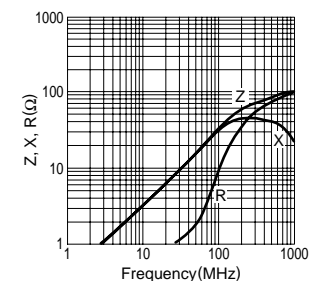

ACB2012H-060

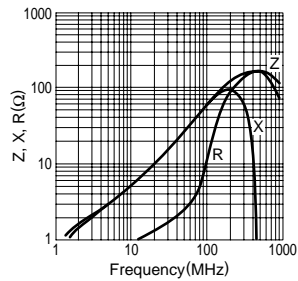

ACB2012H-120

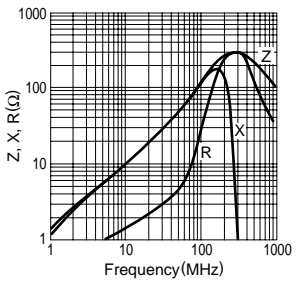

ACB2012H-300

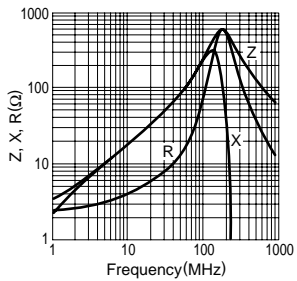

• TEST EQUIPMENT: RF IMPEDANCE ANALYZER YHP4191A